

Centre Number	Candidate Number	Name
---------------	------------------	------

CAMBRIDGE INTERNATIONAL EXAMINATIONS  
General Certificate of Education Ordinary Level

**COMBINED SCIENCE**

**5129/02**

Paper 2

May/June 2003

**2 hours 15 minutes**

Candidates answer on the Question Paper.  
No Additional Materials are required.

**READ THESE INSTRUCTIONS FIRST**

Write your Centre number, candidate number and name on all the work you hand in.  
Write in dark blue or black pen in the spaces provided on the Question Paper.  
You may use a soft pencil for any diagrams, graphs, tables or rough working.  
Do not use staples, paper clips, highlighters, glue or correction fluid.

Answer **all** questions.

At the end of the examination, fasten all your work securely together.

The number of marks is given in brackets [ ] at the end of each question or part question.

A copy of the Periodic Table is printed on page 20.

If you have been given a label, look at the details. If any details are incorrect or missing, please fill in your correct details in the space given at the top of this page.

Stick your personal label here, if provided.

For Examiner's Use	
<b>Total</b>	

This document consists of **18** printed pages and **2** blank pages.

- 1 Fig. 1.1 represents the arrangement of atoms or molecules in four different substances, **A**, **B**, **C** and **D**.

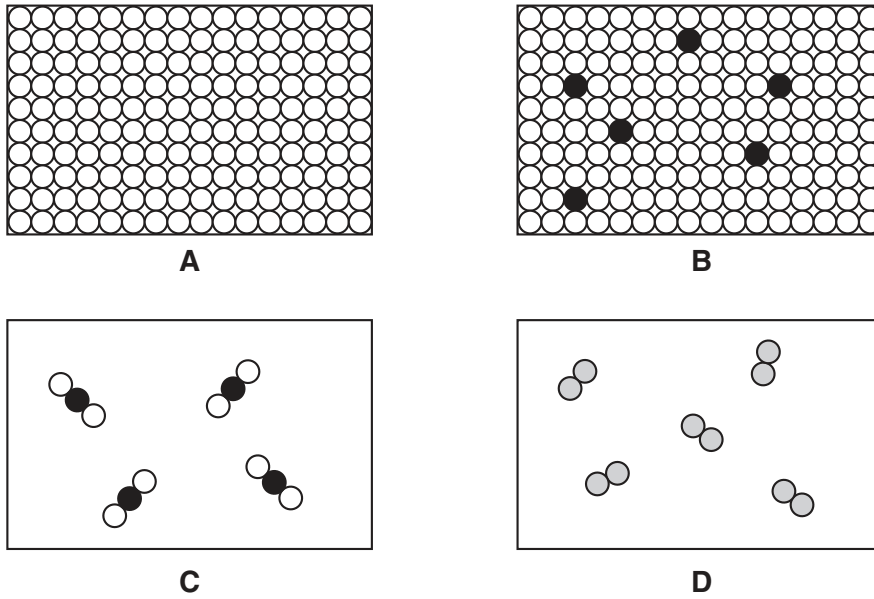

**Fig. 1.1**

- (a) Which substance is an alloy? ..... [1]
- (b) Which substance is a compound? ..... [1]
- (c) Which substances are elements? ..... and ..... [1]
- (d) Which substance could be carbon dioxide? ..... [1]

- 2 A measuring cylinder contains  $80 \text{ cm}^3$  of water and has a total mass of  $300 \text{ g}$ .

A stone is then lowered into the cylinder. The new reading of the volume is  $110 \text{ cm}^3$  and the total mass is  $390 \text{ g}$ .

The readings are shown in Fig. 2.1.

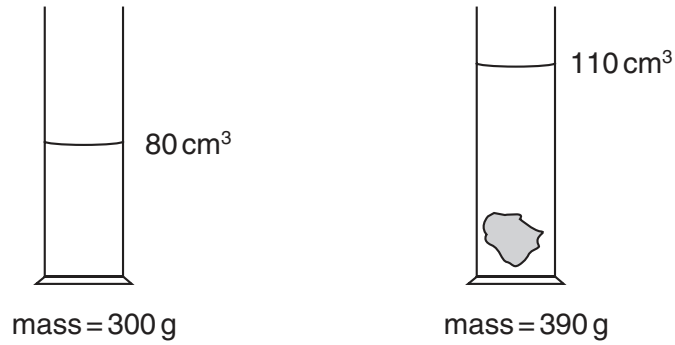

**Fig. 2.1**

- (a) What is the mass of the stone? ..... g [1]
- (b) What is the volume of the stone? .....  $\text{cm}^3$  [1]
- (c) Use your answers to (a) and (b) to calculate the density of the stone.

[3]

- 3 (a) Inspired air differs from expired air.

State three differences between inspired and expired air.

1. ....
2. ....
3. .... [3]

- (b) Fig. 3.1 shows some apparatus for comparing inspired and expired air.

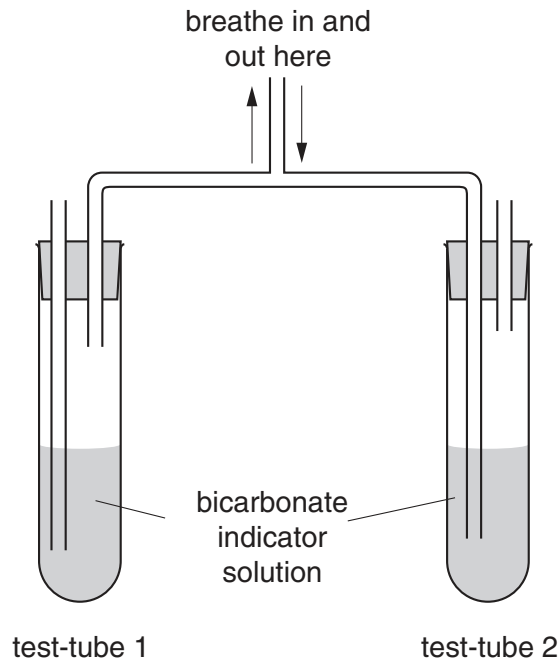

**Fig. 3.1**

Each test-tube contains bicarbonate indicator solution. In atmospheric air, bicarbonate indicator solution is red. In expired air it turns yellow. The reaction is reversible.

At the start of the experiment the bicarbonate indicator in both test-tubes is red. A person breathes in and out through the middle tube.

In which test-tube will the bicarbonate indicator solution go yellow?

..... [1]

(c) The yellow bicarbonate indicator solution is put into the apparatus in Fig. 3.2.

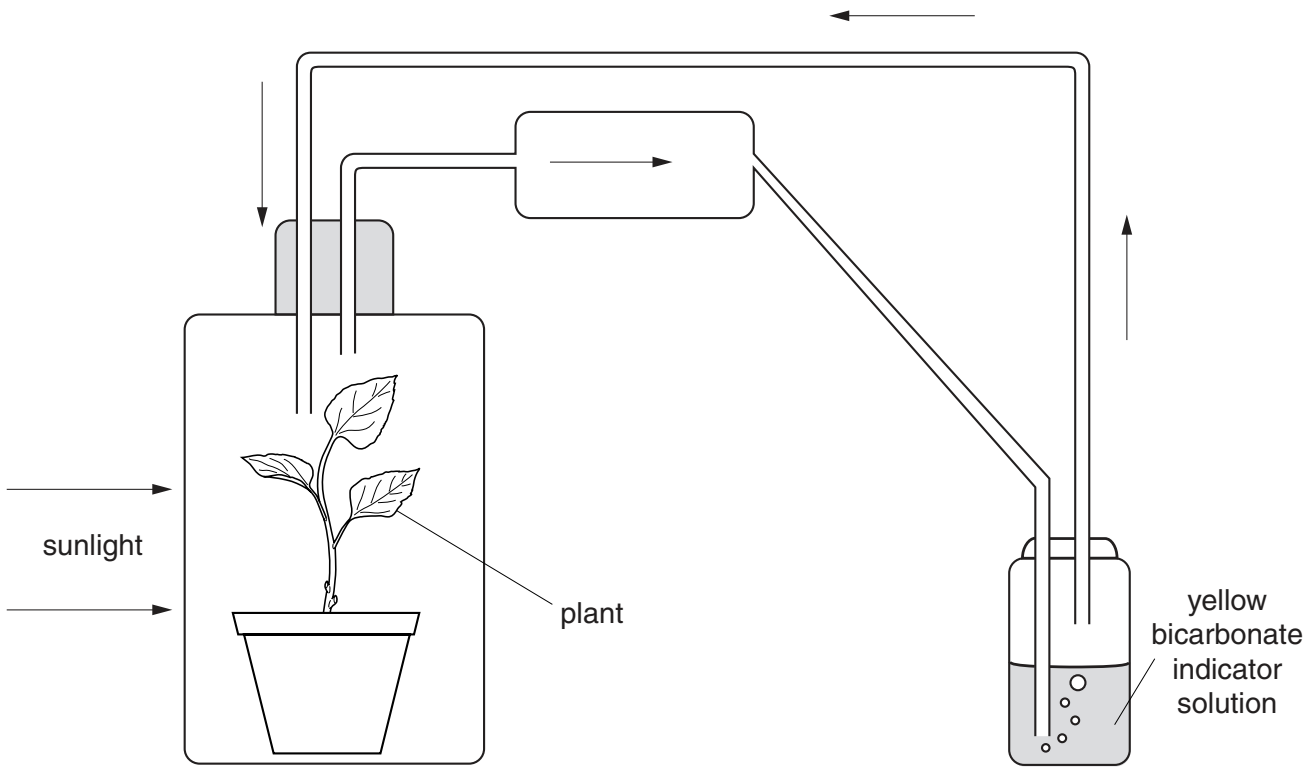

**Fig. 3.2**

The apparatus is left in sunlight for two hours. The yellow solution becomes red again.

(i) Suggest why the bicarbonate indicator changes colour.

.....  
 ..... [1]

(ii) Name the process in the plant that causes the colour change.

..... [1]

(iii) State the word equation for this process taking place in the plant.

.....  
 ..... [2]

- 4 A student investigated the reactivity of some metals. He placed small pieces of the metals copper, iron, magnesium and zinc in test-tubes containing the same volume of hydrochloric acid. The acid in each tube had the same concentration and initial temperature.

His observations are shown in Fig. 4.1.

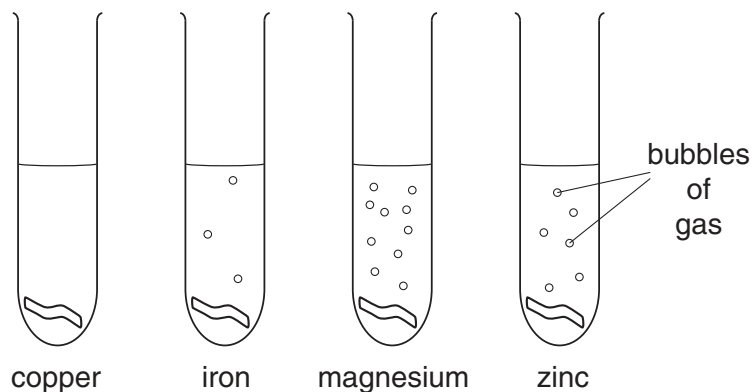

Fig. 4.1

- (a) Use his observations to list the metals in order of reactivity, the most reactive metal first.

1. ....

2. ....

3. ....

4. ....

[2]

- (b) Suggest why the hydrochloric acid should be the same concentration and temperature in each of the test-tubes.

..... [1]

- (c) (i) Name the gas given off when the metals react with hydrochloric acid.

.....

- (ii) State the test for this gas.

.....

.....

[2]

- (d) State the name and formula of the salt formed when zinc reacts with hydrochloric acid.

name ..... formula .....

[2]

- 5 Fig. 5.1 shows how the displacement of particles in a wave varies with distance from the source.

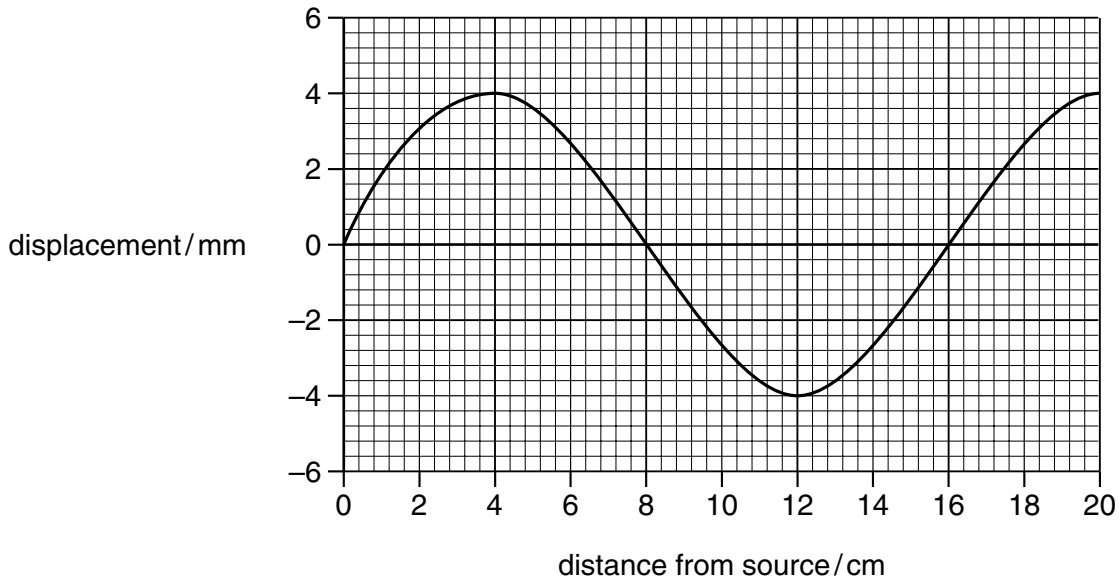

**Fig. 5.1**

- (a) Use Fig. 5.1 to determine

- (i) the wavelength,

..... cm [1]

- (ii) the amplitude.

..... mm [1]

- (b) The wave shown in Fig. 5.1 has a frequency of 5.0 Hz.

- (i) State what is meant by *frequency*.

.....

..... [2]

- (ii) Use your answer to (a)(i) to calculate the speed of the wave.

[3]

6 (a) (i) State three different uses of energy within the body.

- 1. .... [3]
- 2. ....
- 3. .... [3]

(ii) Suggest three ways in which energy can be lost from the body.

- 1. .... [3]
- 2. ....
- 3. .... [3]

(b) The recommended daily energy intake for a man aged 45 is 12 100 kJ and for a 75 year old man is 8 800 kJ.

Suggest a reason for this difference in daily energy intake.

..... [1]

7 Sulphur dioxide is produced when coal is burnt in air. Sulphur dioxide causes acid rain.

(a) Write the symbol equation for the burning of sulphur in oxygen.

..... [1]

(b) When the sulphur dioxide dissolves in rain water what happens to the pH value of the rain water?

..... [1]

(c) State two environmental problems caused by acid rain.

- 1. .... [2]
- 2. .... [2]



8 Fig. 8.1 shows an electric kettle. The heating element heats the water around it.

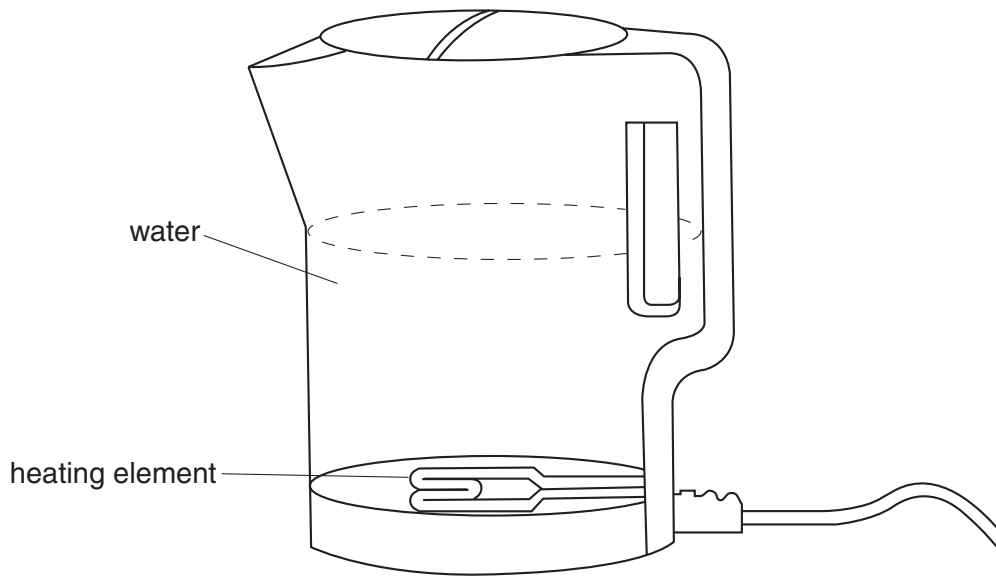

Fig. 8.1

(a) Explain, in detail, how the rest of the water in the kettle is heated by convection.

.....  
 .....  
 ..... [3]

(b) Suggest two reasons why the body of the kettle is made of plastic rather than metal.

1. ....  
 2. .... [2]

(c) The mains plug of the kettle has three connections. One of them is called the **live**. What are the names of the other two connections?

..... and ..... [2]

(d) The mains supply is 230 V. The current in the heating element of the kettle is 8.0 A.

Calculate the resistance of the heating element.

[2]

9 Fig. 9.1 shows a section through part of a green leaf.

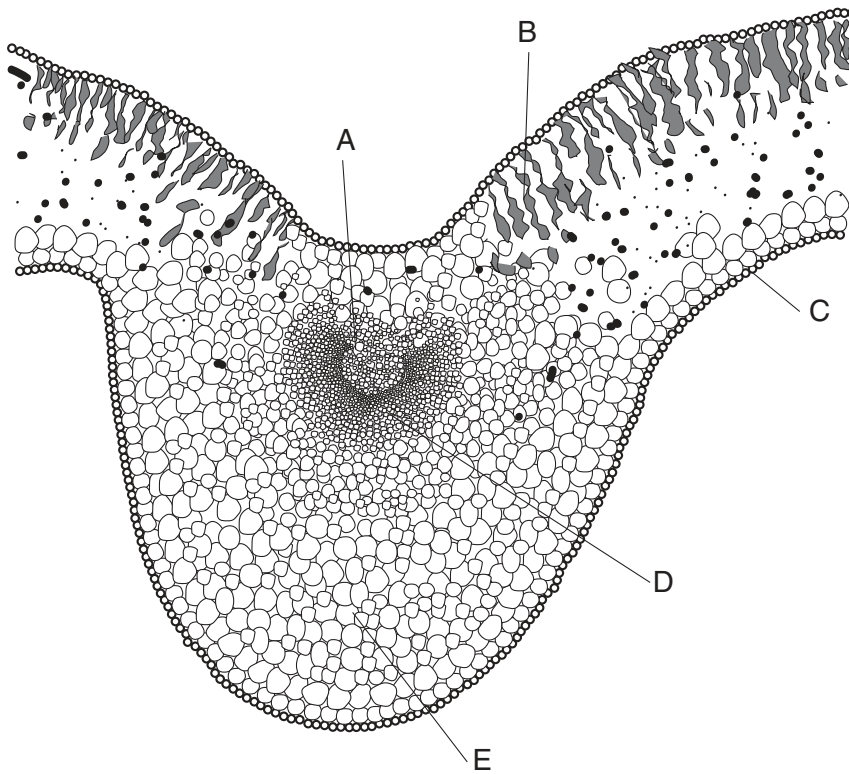

**Fig. 9.1**

(a) Name the tissue in which water is carried through the leaf.

..... [1]

(b) From Fig. 9.1 give

(i) the letter that identifies the tissue in (a), ..... [1]

(ii) the letter that identifies tissue containing chlorophyll. .... [1]

(c) Name the process by which water is lost from the leaf.

..... [1]

10 Ethane and ethene are both hydrocarbons. They can be distinguished from each other using aqueous bromine solution.

(a) (i) State the colour of aqueous bromine solution.

.....

(ii) State what you would see when aqueous bromine solution is added to ethane and to ethene in separate test-tubes.

ethane .....

ethene .....

[3]

(b) Both hydrocarbons burn in oxygen. What are the products of complete combustion of the hydrocarbons?

..... and ..... [2]

11 Fig. 11.1 shows a simple electric bell. When the switch is closed the metal ball hits the gong.

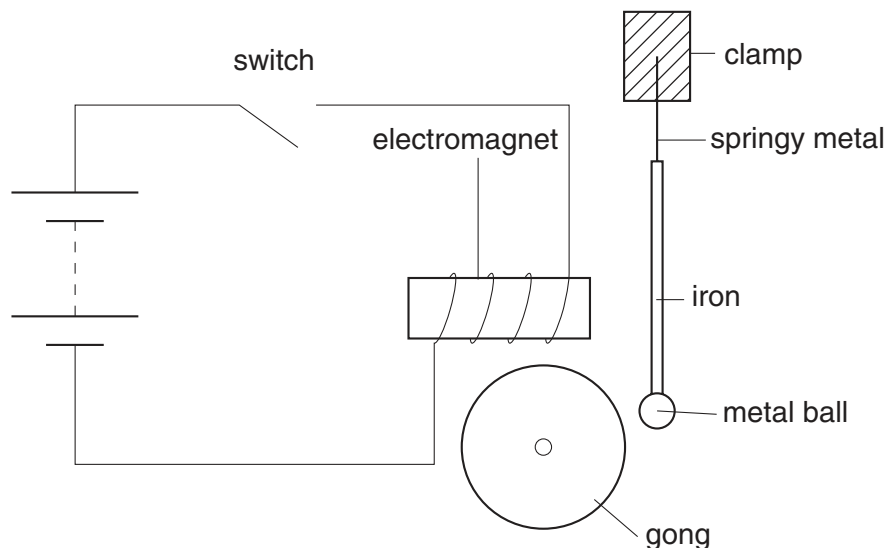

Fig. 11.1

(a) Explain why the metal ball moves when the switch is closed.

.....  
 .....  
 ..... [3]

(b) What difference, if any, does it make if the cells are reversed?

..... [1]

(c) Complete the following sentence about the energy changes taking place in the cells.

The cells change ..... energy into ..... energy. [2]

12 Fig. 12.1 shows a section through a flower.

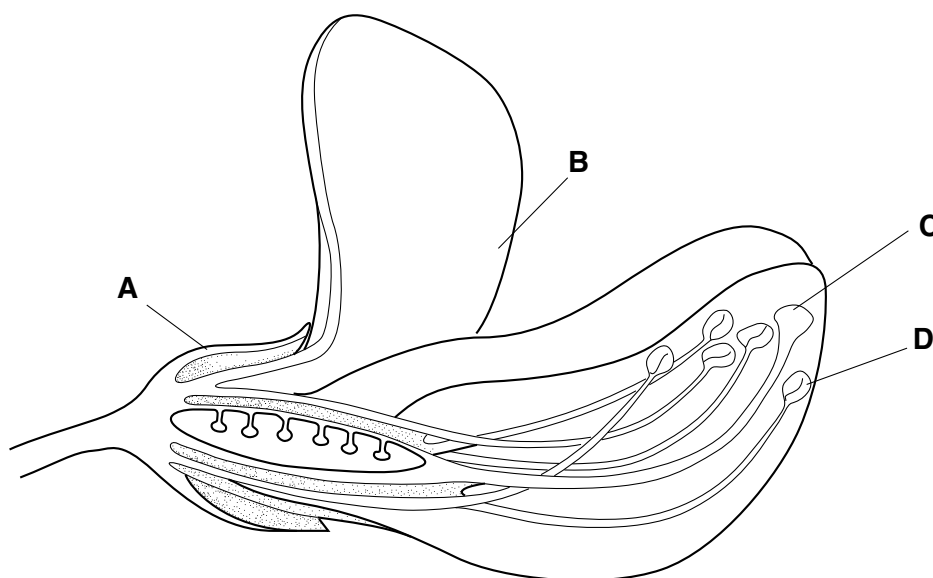

Fig. 12.1

(a) Suggest **one** use for each of the labelled parts.

A .....

B .....

C .....

D ..... [4]

(b) On Fig. 12.1, mark with a cross (X) a place where fertilisation occurs. [1]

(c) After fertilisation, what do the ovule and the ovary become?

The ovule becomes a .....

The ovary becomes a ..... [2]

- 13 (a) Ammonia contains nitrogen and hydrogen and is represented by the formula  $\text{NH}_3$ .

Use the information from the Periodic Table to help you complete Fig. 13.1 to show the arrangement of the outer shell electrons in a molecule of ammonia.

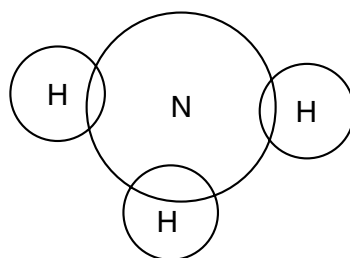

Fig. 13.1

[2]

- (b) (i) Name the type of bonding present in ammonia.

.....

[1]

- (ii) Explain, in terms of particles, why the boiling point of ammonia is  $-34\text{ }^\circ\text{C}$ .

.....

.....

..... [2]

14 Fig. 14.1 shows a bar magnet being pushed into a coil of wire to induce an e.m.f.

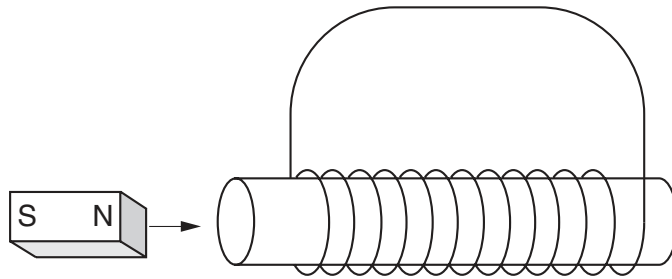

Fig. 14.1

(a) State three factors that affect the size of the induced e.m.f.

- 1. .... [3]
- 2. ....
- 3. ....

(b) The induced e.m.f. produces a current through the coil.

State two ways by which the current may be reversed.

- 1. .... [2]
- 2. ....

15 Fig. 15.1 shows some plant tissue.

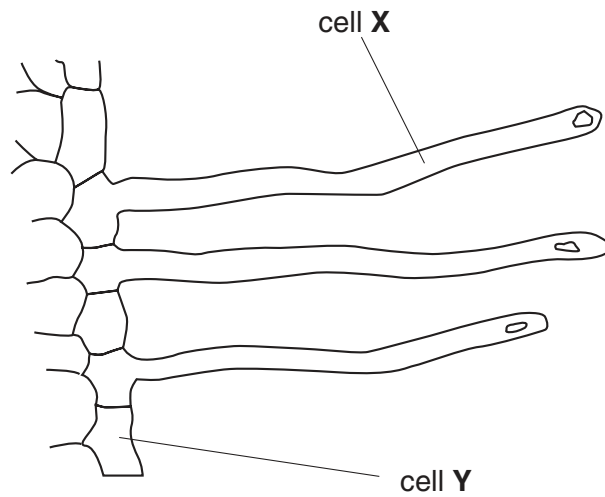

Fig. 15.1

(a) (i) Name the type of cell marked X.

..... [1]

(ii) Name the process by which water enters cell X.

..... [1]

(iii) Suggest why cell X is better at taking in water than cell Y.

.....  
..... [1]

(b) Suggest four ways in which water is used in a plant.

1. ....
2. ....
3. ....
4. .... [4]

16 An element **X** exists as two isotopes  $^{28}\text{X}$  and  $^{30}\text{X}$ .

(a) What are *isotopes*?

.....  
 ..... [2]

(b) Complete the following table.

isotope	number of protons	number of neutrons	number of electrons
$^{28}\text{X}$			14
$^{30}\text{X}$	14	16	

[3]

(c) How do the chemical properties of each isotope of the element compare with each other? Explain your answer.

.....  
 .....  
 ..... [2]

(d) Use the Periodic Table to identify element **X**.

..... [1]



17 Ball **A** and ball **B** in Fig. 17.1 are both made of polythene.

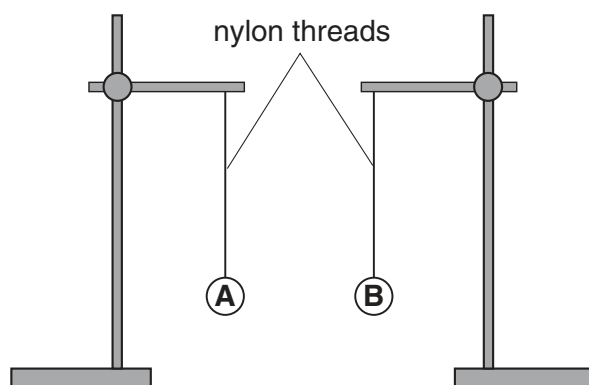

Fig. 17.1

- (a) A polythene ball, initially uncharged, can be given a negative charge by rubbing it with a duster.

What type of charge does the duster gain? ..... [1]

- (b) Fig. 17.2 shows the two balls after they have each been given a negative charge.

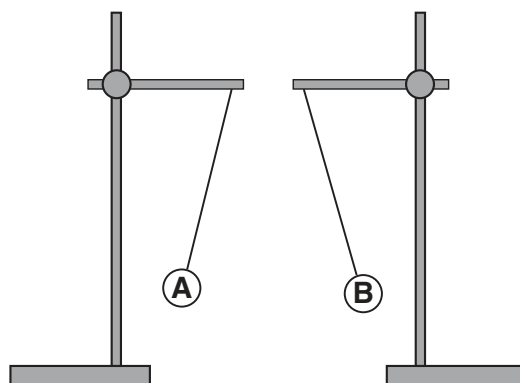

Fig. 17.2

Explain why the two balls do not hang vertically.

..... [1]





**DATA SHEET**  
**The Periodic Table of the Elements**  
**Group**

I	II	III	IV	V	VI	VII	O																										
7 <b>Li</b> Lithium 3	9 <b>Be</b> Beryllium 4	11 <b>B</b> Boron 5	12 <b>C</b> Carbon 6	14 <b>N</b> Nitrogen 7	16 <b>O</b> Oxygen 8	19 <b>F</b> Fluorine 9	20 <b>Ne</b> Neon 10																										
23 <b>Na</b> Sodium 11	24 <b>Mg</b> Magnesium 12	27 <b>Al</b> Aluminium 13	28 <b>Si</b> Silicon 14	31 <b>P</b> Phosphorus 15	32 <b>S</b> Sulphur 16	35.5 <b>Cl</b> Chlorine 17	40 <b>Ar</b> Argon 18																										
39 <b>K</b> Potassium 19	40 <b>Ca</b> Calcium 20	45 <b>Sc</b> Scandium 21	48 <b>Ti</b> Titanium 22	59 <b>Co</b> Cobalt 27	64 <b>Cu</b> Copper 29	79 <b>Se</b> Selenium 34	84 <b>Kr</b> Krypton 36																										
85 <b>Rb</b> Rubidium 37	88 <b>Sr</b> Strontium 38	89 <b>Y</b> Yttrium 39	91 <b>Zr</b> Zirconium 40	103 <b>Rh</b> Rhodium 45	108 <b>Ag</b> Silver 47	128 <b>Te</b> Tellurium 52	131 <b>Xe</b> Xenon 54																										
133 <b>Cs</b> Caesium 55	137 <b>Ba</b> Barium 56	139 <b>La</b> Lanthanum 57	178 <b>Hf</b> Hafnium 72	192 <b>Ir</b> Iridium 77	197 <b>Au</b> Gold 79	209 <b>Po</b> Polonium 84	226 <b>Rn</b> Radon 86																										
87 <b>Fr</b> Francium	88 <b>Ra</b> Radium	227 <b>Ac</b> Actinium																															
<table border="1" style="width: 100%; border-collapse: collapse; text-align: center;"> <tr> <td>1 <b>H</b> Hydrogen 1</td> <td>2 <b>He</b> Helium 2</td> </tr> </table>								1 <b>H</b> Hydrogen 1	2 <b>He</b> Helium 2																								
1 <b>H</b> Hydrogen 1	2 <b>He</b> Helium 2																																
<table border="1" style="width: 100%; border-collapse: collapse; text-align: center;"> <tr> <td>65 <b>Zn</b> Zinc 30</td> <td>66 <b>Cd</b> Cadmium 48</td> <td>68 <b>Pt</b> Platinum 78</td> <td>70 <b>Ga</b> Gallium 31</td> <td>73 <b>Ge</b> Germanium 32</td> <td>75 <b>As</b> Arsenic 33</td> <td>76 <b>Os</b> Osmium 76</td> <td>77 <b>Ir</b> Iridium 77</td> <td>78 <b>Pd</b> Palladium 46</td> <td>79 <b>Hg</b> Mercury 80</td> <td>80 <b>Tl</b> Thallium 81</td> <td>81 <b>Pb</b> Lead 82</td> <td>82 <b>Bi</b> Bismuth 83</td> <td>83 <b>Sb</b> Antimony 51</td> <td>84 <b>Po</b> Polonium 84</td> <td>85 <b>At</b> Astatine 85</td> <td>86 <b>Rn</b> Radon 86</td> </tr> </table>								65 <b>Zn</b> Zinc 30	66 <b>Cd</b> Cadmium 48	68 <b>Pt</b> Platinum 78	70 <b>Ga</b> Gallium 31	73 <b>Ge</b> Germanium 32	75 <b>As</b> Arsenic 33	76 <b>Os</b> Osmium 76	77 <b>Ir</b> Iridium 77	78 <b>Pd</b> Palladium 46	79 <b>Hg</b> Mercury 80	80 <b>Tl</b> Thallium 81	81 <b>Pb</b> Lead 82	82 <b>Bi</b> Bismuth 83	83 <b>Sb</b> Antimony 51	84 <b>Po</b> Polonium 84	85 <b>At</b> Astatine 85	86 <b>Rn</b> Radon 86									
65 <b>Zn</b> Zinc 30	66 <b>Cd</b> Cadmium 48	68 <b>Pt</b> Platinum 78	70 <b>Ga</b> Gallium 31	73 <b>Ge</b> Germanium 32	75 <b>As</b> Arsenic 33	76 <b>Os</b> Osmium 76	77 <b>Ir</b> Iridium 77	78 <b>Pd</b> Palladium 46	79 <b>Hg</b> Mercury 80	80 <b>Tl</b> Thallium 81	81 <b>Pb</b> Lead 82	82 <b>Bi</b> Bismuth 83	83 <b>Sb</b> Antimony 51	84 <b>Po</b> Polonium 84	85 <b>At</b> Astatine 85	86 <b>Rn</b> Radon 86																	
<table border="1" style="width: 100%; border-collapse: collapse; text-align: center;"> <tr> <td>140 <b>Ce</b> Cerium 58</td> <td>141 <b>Pr</b> Praseodymium 59</td> <td>144 <b>Nd</b> Neodymium 60</td> <td>150 <b>Sm</b> Samarium 62</td> <td>152 <b>Eu</b> Europium 63</td> <td>157 <b>Gd</b> Gadolinium 64</td> <td>162 <b>Dy</b> Dysprosium 66</td> <td>165 <b>Ho</b> Holmium 67</td> <td>167 <b>Er</b> Erbium 68</td> <td>169 <b>Tm</b> Thulium 69</td> <td>173 <b>Yb</b> Ytterbium 70</td> <td>175 <b>Lu</b> Lutetium 71</td> <td>232 <b>Th</b> Thorium 90</td> <td>238 <b>U</b> Uranium 92</td> <td>238 <b>Pa</b> Protactinium 91</td> <td>93 <b>Np</b> Neptunium 93</td> <td>94 <b>Pu</b> Plutonium 94</td> <td>95 <b>Am</b> Americium 95</td> <td>96 <b>Cm</b> Curium 96</td> <td>97 <b>Bk</b> Berkelium 97</td> <td>98 <b>Cf</b> Californium 98</td> <td>99 <b>Es</b> Einsteinium 99</td> <td>100 <b>Fm</b> Fermium 100</td> <td>101 <b>Md</b> Mendelevium 101</td> <td>102 <b>No</b> Nobelium 102</td> <td>103 <b>Lr</b> Lawrencium 103</td> </tr> </table>								140 <b>Ce</b> Cerium 58	141 <b>Pr</b> Praseodymium 59	144 <b>Nd</b> Neodymium 60	150 <b>Sm</b> Samarium 62	152 <b>Eu</b> Europium 63	157 <b>Gd</b> Gadolinium 64	162 <b>Dy</b> Dysprosium 66	165 <b>Ho</b> Holmium 67	167 <b>Er</b> Erbium 68	169 <b>Tm</b> Thulium 69	173 <b>Yb</b> Ytterbium 70	175 <b>Lu</b> Lutetium 71	232 <b>Th</b> Thorium 90	238 <b>U</b> Uranium 92	238 <b>Pa</b> Protactinium 91	93 <b>Np</b> Neptunium 93	94 <b>Pu</b> Plutonium 94	95 <b>Am</b> Americium 95	96 <b>Cm</b> Curium 96	97 <b>Bk</b> Berkelium 97	98 <b>Cf</b> Californium 98	99 <b>Es</b> Einsteinium 99	100 <b>Fm</b> Fermium 100	101 <b>Md</b> Mendelevium 101	102 <b>No</b> Nobelium 102	103 <b>Lr</b> Lawrencium 103
140 <b>Ce</b> Cerium 58	141 <b>Pr</b> Praseodymium 59	144 <b>Nd</b> Neodymium 60	150 <b>Sm</b> Samarium 62	152 <b>Eu</b> Europium 63	157 <b>Gd</b> Gadolinium 64	162 <b>Dy</b> Dysprosium 66	165 <b>Ho</b> Holmium 67	167 <b>Er</b> Erbium 68	169 <b>Tm</b> Thulium 69	173 <b>Yb</b> Ytterbium 70	175 <b>Lu</b> Lutetium 71	232 <b>Th</b> Thorium 90	238 <b>U</b> Uranium 92	238 <b>Pa</b> Protactinium 91	93 <b>Np</b> Neptunium 93	94 <b>Pu</b> Plutonium 94	95 <b>Am</b> Americium 95	96 <b>Cm</b> Curium 96	97 <b>Bk</b> Berkelium 97	98 <b>Cf</b> Californium 98	99 <b>Es</b> Einsteinium 99	100 <b>Fm</b> Fermium 100	101 <b>Md</b> Mendelevium 101	102 <b>No</b> Nobelium 102	103 <b>Lr</b> Lawrencium 103								

\*58-71 Lanthanoid series  
†90-103 Actinoid series

**Key**

a	X
a = relative atomic mass	X = atomic symbol
b	b = proton (atomic) number

The volume of one mole of any gas is 24 dm<sup>3</sup> at room temperature and pressure (r.t.p.).